

# BT Breathers

with T.R.A.P.<sup>™</sup> Technology

## Self-Regenerating Moisture and Particulate Breathers

Protect your uptime, critical hydraulic & lube assets and fluid life. Donaldson Hy-Pro Thermally Reactive Advanced Protection (T.R.A.P.) breathers are critical in Donaldson Hy-Pro's Total System Cleanliness approach as a barrier preventing airborne particles and water from entering reservoirs and gearboxes. Unlike traditional dessicant breathers, T.R.A.P. breathers can self-regenerate their water-holding capacity, extending the life of the breather and lowering the total cost of ownership.

Donaldson  
HY-PRO<sup>™</sup>



THERMALLY REACTIVE  
ADVANCED PROTECTION

[hyprofiltration.com/](http://hyprofiltration.com/)



## Long life, fewer change-outs.

Unlike traditional silica gel breathers, Donaldson Hy-Pro T.R.A.P. breathers utilize a technology that allows the breather to continuously regenerate its water absorbing capacity. This technology allows the breather life to be extended up to 6 months. By reducing the number of change-outs required, money is saved in both parts and labor.

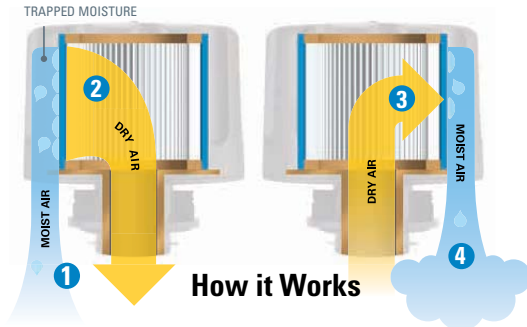

## Self-Regenerating Water Absorbing Capacity.

Atmospheric moisture is a continuous threat to efficient operations of your equipment and machinery. Donaldson Hy-Pro T.R.A.P. Breathers absorb water from the air coming into the reservoir. Air is heated and dried in the warm hydraulic reservoir. As the tank exhales, the dry air strips the moisture from the saturated T.R.A.P. media, regenerating its life.

## Dual contamination prevention.

Each Donaldson Hy-Pro T.R.A.P. Breather is equipped with an internal 3 micron particulate filter along with a proprietary water absorbing media to keep your system both clean and dry. T.R.A.P. Breathers utilize a full pleated media pack to maximize dirt holding capacity and minimize pressure drop.

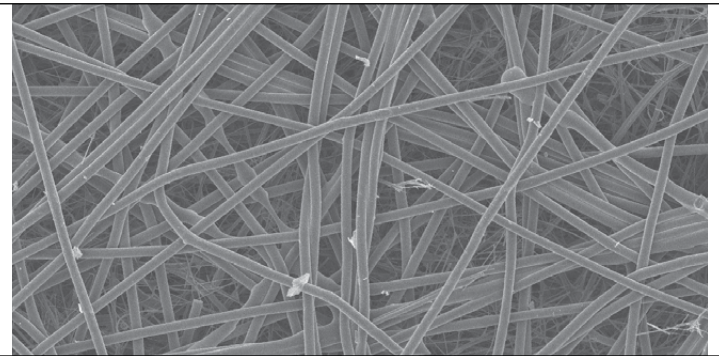

## Complete drying system.

Achieve the ultimate head space drying system when paired with the TMR-Air or TMR-N<sub>2</sub> reservoir driers. The combination of the two technologies will eliminate condensation issues in tanks and reservoirs.

## The perfect fit for your system.



Hy-Dry Breathers come in a variety of sizes, connections, and other options designed for countless applications. Whether you're installing on a small gearbox reservoir or on-board a high vibration mobile application, there's a Donaldson Hy-Pro T.R.A.P. Breather suited perfectly to fit your needs.



## Total Systems Cleanliness

Used in conjunction with more robust particulate filtration, Donaldson Hy-Pro T.R.A.P. Breathers are a pivotal component to achieving Total Systems Cleanliness and ensuring your equipment is protected from all forms of airborne contamination.

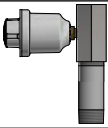
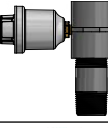
# BT Reservoir Adapters

Part Number	Element Connection	Reservoir Connection	Material	Indicator Set Point	Use with Breather	
BT25K15	3/4" FNPT	3/4" MNPT	Stainless Steel	Indicator Kid Included 20" H2O/5 kPa Trip Point	HPBT25N12-X	
BT45K15	1" FNPT	1" MNPT	Plastic	Indicator Kid Included 20" H2O/5 kPa Trip Point	HPBT45N16-X	
136501-00520	3/8 - 24 UN		Plastic	20" H2O/5 kPa Trip Point	Replacement Indicator	
P570353	1" FNPT & 1 1/2 -16 UN	Bayonet	Plastic	N/A	HPBT45	

# BT Disposable Cartridge Breathers



Model	HPBT3N4-X	HPBT3N6-X	HPBT25N12-X	HPBT45N16-X	HPBT45N16-DX	HPBT25UNST1.5-DX
Height	2.21" 5.6 cm	2.21" 5.6 cm	2.85" 7.2 cm	4.57" 11.6 cm	4.57" 11.6 cm	14.29" 36.3 cm
Diameter	1.65" 4.2 cm	1.65" 4.2 cm	3.18" 8.1 cm	4.5" 11.4 cm	4.5" 11.4 cm	6.95" 11.7 cm
Connection	1/4" MNPT	3/8" MNPT	3/4" MNPT	1" MNPT	1" MNPT	1.5" UNF female
Allowable Tank Connections	1/4" BSPT 1/4" FNPT	3/8" BSPT 3/8" FNPT	3/4" BSPT 3/4" G 3/4" FNPT SAE-12	1" BSPT 1" G 1" FNPT SAE-16	1" BSPT 1" G 1" FNPT SAE-16	
Airflow	3 cfm 5 m <sup>3</sup> /h	3 cfm 5 m <sup>3</sup> /h	25 cfm 42 m <sup>3</sup> /h	45 cfm 76 m <sup>3</sup> /h	45 cfm 76 m <sup>3</sup> /h	25 cfm 42 m <sup>3</sup> /h
Reservoir Flow	22 gpm 85 lpm	22 gpm 85 lpm	337 gpm 1274 lpm	337 gpm 1274 lpm	337 gpm 1274 lpm	187 gpm 708 lpm
Particulate Efficiency	3μ <sub>(c)</sub> @ 97%	3μ <sub>(c)</sub> @ 97%	3μ <sub>(c)</sub> @ 97%	3μ <sub>(c)</sub> @ 97%	3μ <sub>(c)</sub> @ 97%	3μ <sub>(c)</sub> @ 97%
Material	ABS Plastic	ABS Plastic	Steel E-coated	ABS Plastic	ABS Plastic	Plastic/stainless
Indicator	None	None	None	None	Electric LED light	Visual

For all up to date option details and compatibilities, please reference our Contamination Solutions Price List or contact customer service.

## T.R.A.P. Performance Data

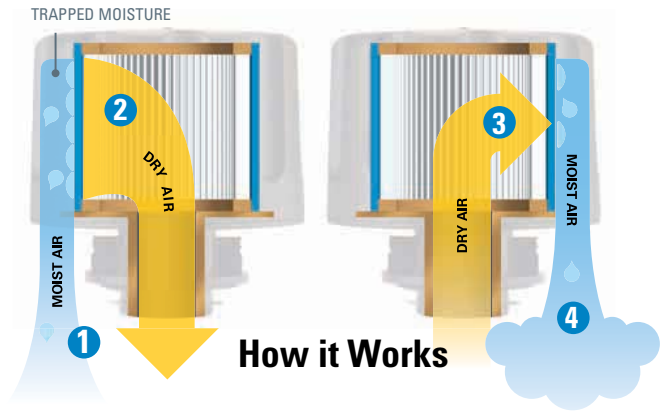
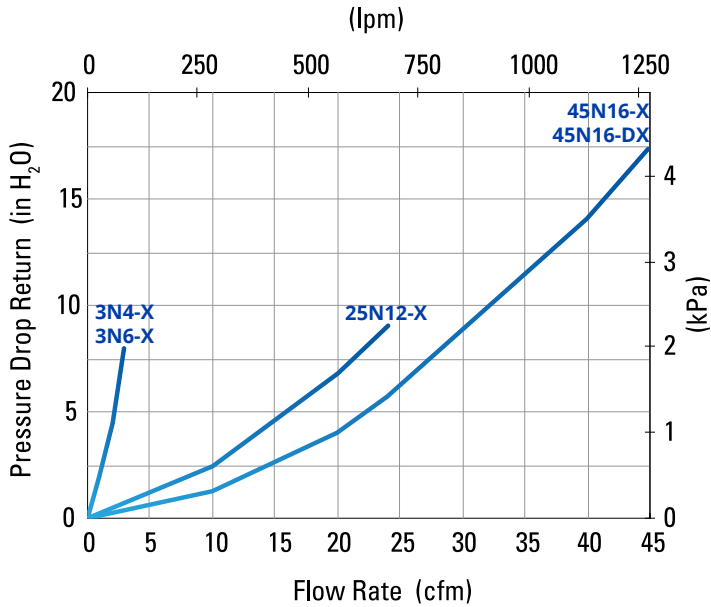

### INTAKE CYCLE (INHALATION)

- 1 The circuit "breathes in" air containing moisture vapor.
- 2 The T.R.A.P. breather strips moisture and particulate from the incoming air, allowing only clean, dry air to enter the circuit.

### OUTFLOW CYCLE (EXHALATION)

- 3 During the "exhalation" cycle, the T.R.A.P. breather allows unrestricted airflow outward.
- 4 The outflow of dry air picks up the moisture collected by the T.R.A.P. breather during intake, and "blows it back out" – fully regenerating the breather's water-holding capacity.

## BT Installation Drawing

HPBT3N4-X

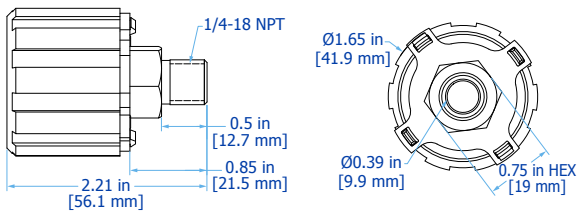

HPBT25UNST1.5-DX

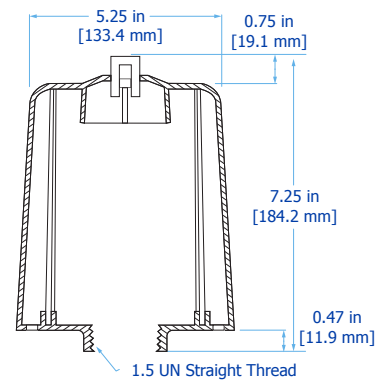

HPBT3N6-X

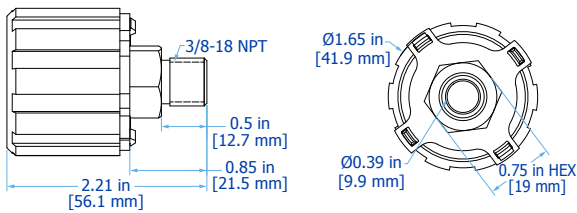

HPBT45N16-X

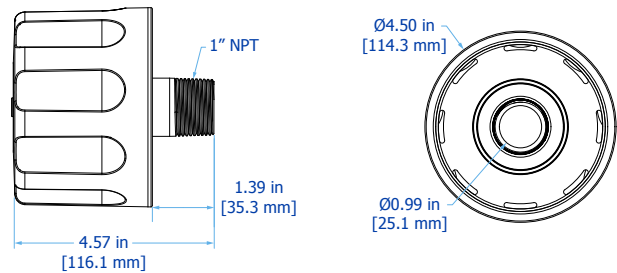

HPBT25N12-X

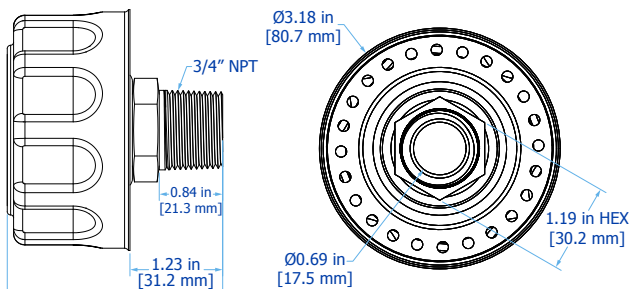

HPBT45N16-DX

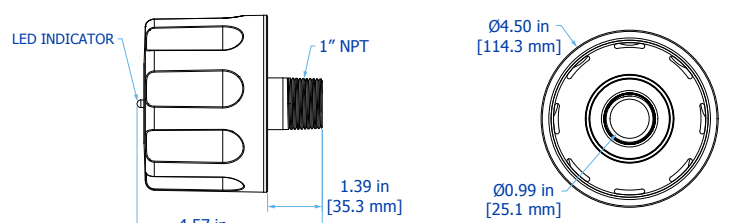

Want to find out more? Get in touch.

hyprofiltration.com  
info@hyprofiltration.com  
+1 317 849 3535

© 2025 Donaldson Company, Inc. All rights reserved.

Donaldson  
HY-PRO™

F119904-022825-E M